

This collection depicts the finest timber bollards available in the world today. Most designs can be made from nominal 8 x 8 (7-1/4" x 7-1/4" net) or 12 x 12 (11-1/4" x 11-1/4" net) free-of-heart-center (F.O.H.C.) Douglas fir timbers. Supplied square or lathe-turned full-length to a constant diameter, these sculpted timbers are offered in (exposed) heights above grade of 2'6", 3'0" and 3'6". Other heights are available.

When specified in the standard direct-burial form, timber bollards are supplied with an additional two feet of length for embedment purposes. All TimberForm wood bollards are pressure treated with preservative after receiving the **MaxTreat™** preservative enhancement process on flat surfaces which will be at or below grade. See lexicon at right for technical details.

Removable bollards, for use as roadway or path barriers are furnished with a pavement socket and are suitable for use with a standard padlock (not included). A hole cover is offered for those times when the bollard is removed.

Custom timber bollards from your design can be produced to TimberForm quality standards. Using the lexicon shown at right, communicate your design ideas to your local TimberForm representative or to our design headquarters.

The TimberForm Timber Bollard Lexicon

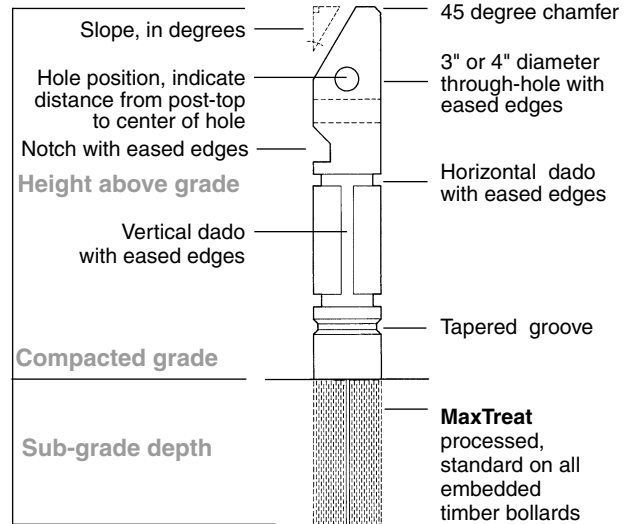

TimberForm Timber Bollards	Model Number	Nominal Timber Size	Height	Mounting
Timber Bollard with Directional Arrow	2553-3¹	6 x 6 [150 x 150mm]	2' 10" [865mm]	-E*
	-E Add this suffix for embedment (permanent) mounting.			



2553-3

Material: Seasoned free-of-heart-center Douglas fir timbers, square embedded timber ends **MaxTreat** processed prior to preservative treatment after **all fabrication completed**.

Notes: * Supplied as standard for embedment (permanent) mounting.

¹ When ordering, indicate arrow direction using analog clock settings ("3" Three o'clock position is shown).

TimberForm Timber Bollards	Model Numbers	Nominal Timber Size	Height	Mounting
Timber Bollard	Even Model Numbers	12 x 12 [305 x 305mm]	2' 6", 3' 0" or 3' 6" [760, 915 or 1065mm]	-E* or -R
	Odd Model Numbers	8 x 8 [205 x 205mm]	2' 6", 3' 0" or 3' 6" [760, 915 or 1065mm]	-E* or -R
	-E Add this suffixed for embedment (permanent) mounting option. -R¹ Add this suffix for removable mounting option. -LT² Add this suffix for lathe-turned (round) option.			

Material: Seasoned free-of-heart-center Douglas fir timbers, square embedded timber ends **MaxTreat** processed prior to pressure preservative treatment after **all fabrication completed**.

Options: Bollard height, mounting method and lathe-turning.

Notes: * Supplied as standard for embedment (permanent) mounting.

¹ A hole cover is available for removable bollards. Specify Model **2500-RC**. Removable mount not offered in the 2' 6" [760mm] height on Models **2564, 2565, 2572, 2573, 2592** and **2593**.

² Lathe-turning not available for models **2584** through **2599**.

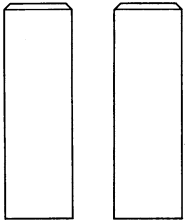

2560 12 x 12
2561 8 x 8

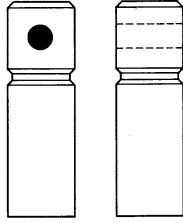

2562 12 x 12
2563 8 x 8

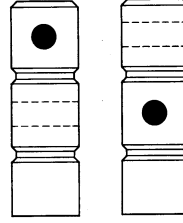

2564 12 x 12
2565 8 x 8

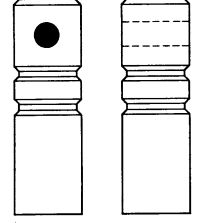

2566 12 x 12
2567 8 x 8

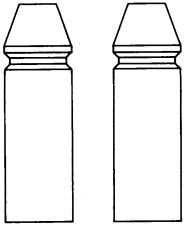

2568 12 x 12
2569 8 x 8

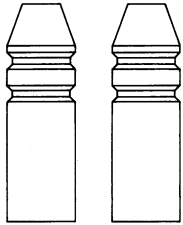

2570 12 x 12
2571 8 x 8

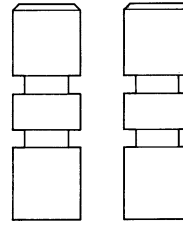

2572 12 x 12
2573 8 x 8

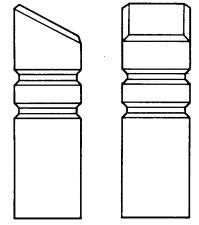

2584 12 x 12
2585 8 x 8

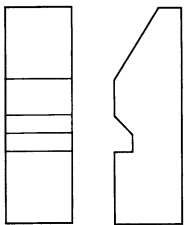

2586 12 x 12
2587 8 x 8

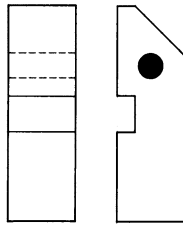

2588 12 x 12
2589 8 x 8

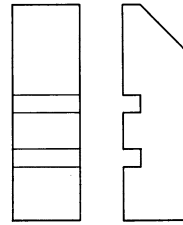

2590 12 x 12
2591 8 x 8

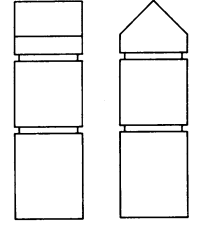

2592 12 x 12
2593 8 x 8

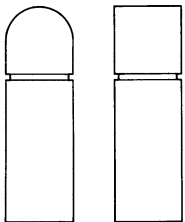

2594 12 x 12
2595 8 x 8

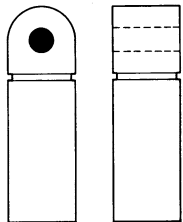

2596 12 x 12
2597 8 x 8

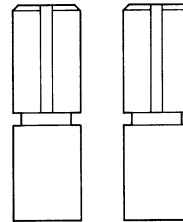

2598 12 x 12
2599 8 x 8

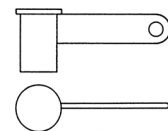

2500-RC
 Hole Cover
 (enlarged detail)

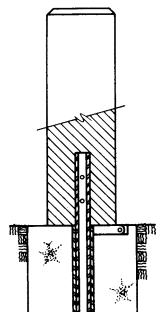

2560-3-R
 Removable
 Mount option